



SPACE CREATOR VEHICLE PARTITION

FEATURING BDRH (BIDIRECTIONAL RECESSED HOUSING)

(U.S. Patent No. 8,690,216)

2025+ RAM 1500 TRADESMAN

Installation Instructions

Space Creator with High Security/High Visibility Window - 475-2241

Space Creator with Full Window w/Safety Wire Window - 475-2252

Transfer Kit - 475-2246

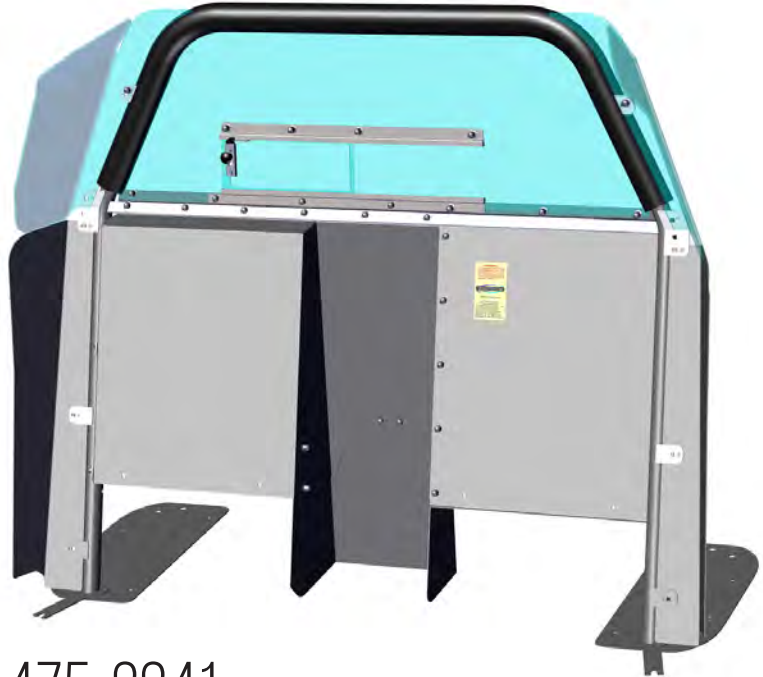

475-2241

Space Creator Vehicle Partition with HS/HV Window
Featuring Bidirectional Recessed Housing



475-2252

Space Creator Vehicle Partition with Full Window Safety Wire
Featuring Bidirectional Recessed Housing

Before beginning the installation, confirm that you have received all of the parts for your package.
Read the instructions completely before starting installation.
Always install Cargo Barrier before Partition if ordered.



Partition with HSHV window
(High Security/High Visibility)



Partition with Secure Grid window



BDRH
(Bidirectional Recessed Housing)

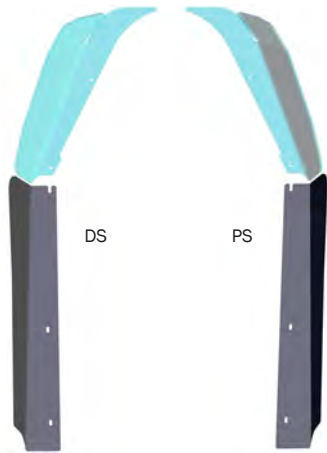

Wings Set



(2) Mounting Foot

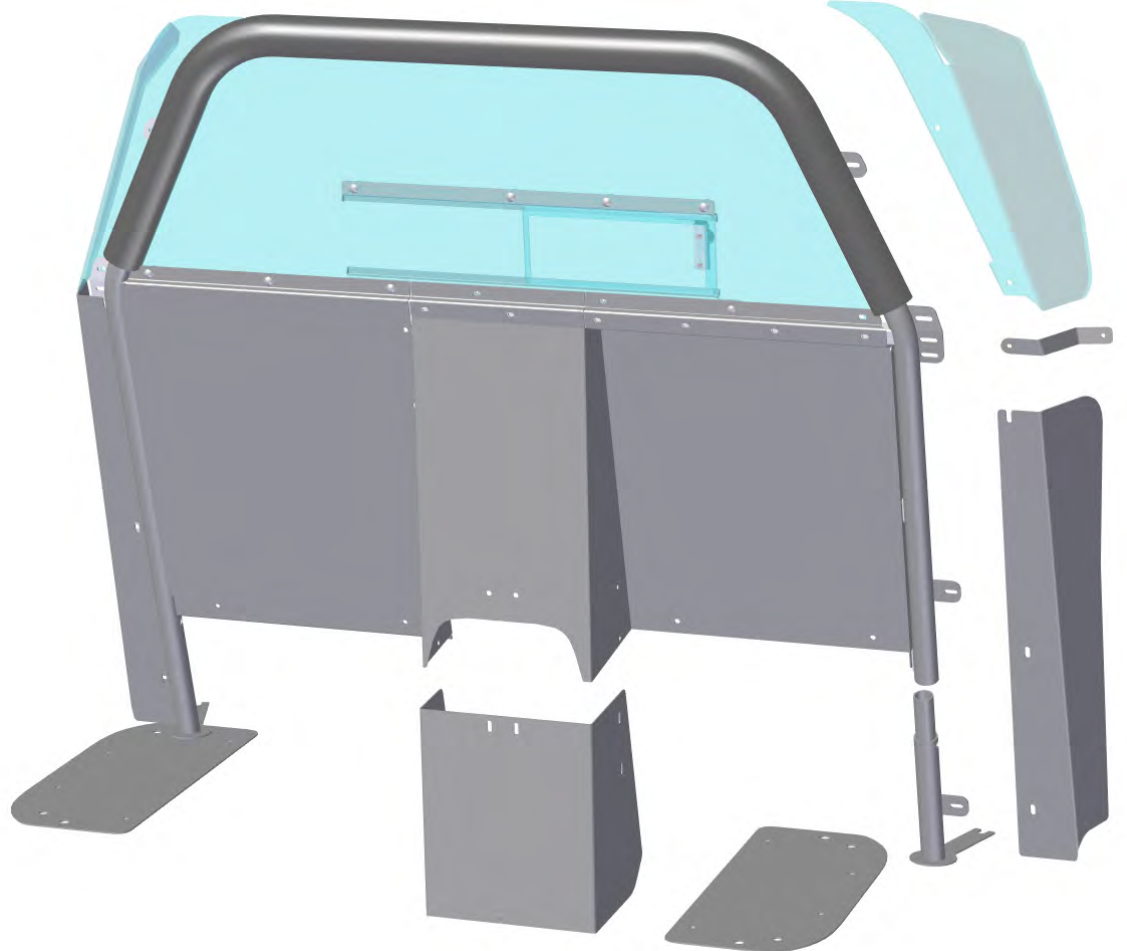

Storage Box Cover Plates.



Center HSEP



HSEP: High Security Extension Panel
optional

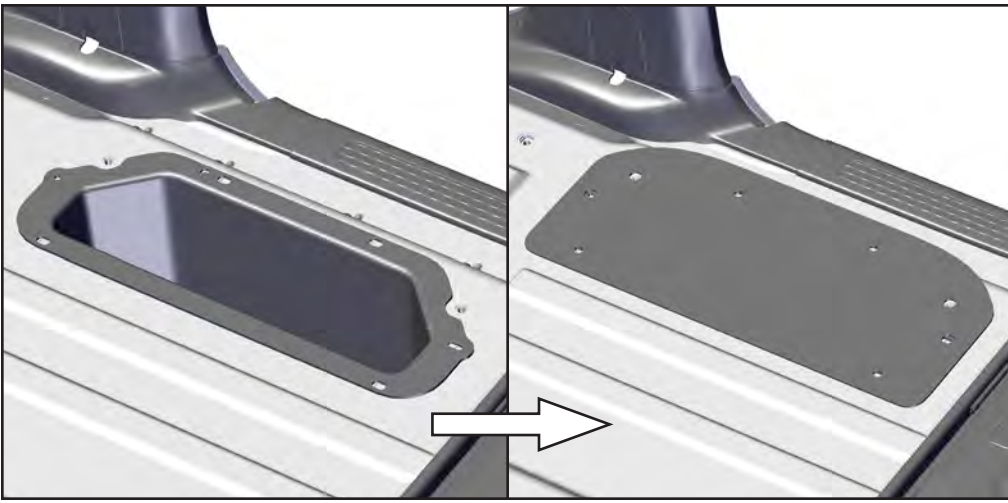

1. Remove the Storage Lid from the PS/DS Storage Compartments.
 - A. The (2) M6-10mm hex head bolts with washer and M8-1.25" Cargo Tie Down Loop hardware will be replaced back into the holes they were removed from.
 - B. The (4) M6-1 pan head bolts will be used to secure the Cover Plate.



2. Move the PS/DS Seats completely forward, remove the rear outer trim covers exposing the OEM seat bolt. Loosen the bolt enough to slide the Mounting Foot into position.

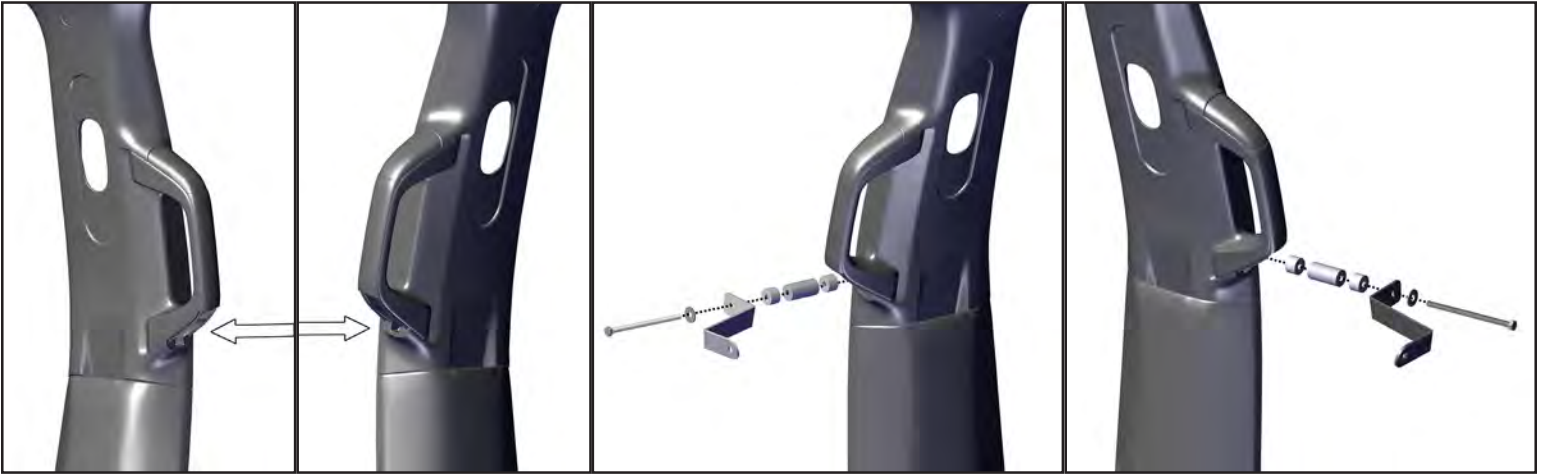

3. On the B-Pillar, remove the cover from lower section of the handle assist with a small pick. Remove the OEM hardware and replace it with M6 Bolt, B Pillar Bracket and Spacers.



4. Install the Partition Frame into the vehicle through the Driver Side and position onto the Mounting Feet.



5. Lean the Partition Frame forward and loosely attach DS/PS B-Pillar Brackets to the middle hold of the frame. Center the Partition. Once centered, tighten all hardware.



6. Outside side of the vehicle, loosely attach the Center HSEP onto the BDRH.

STEPS 7-9 (FOR SECURE GRID WINDOW ASSEMBLY ONLY)

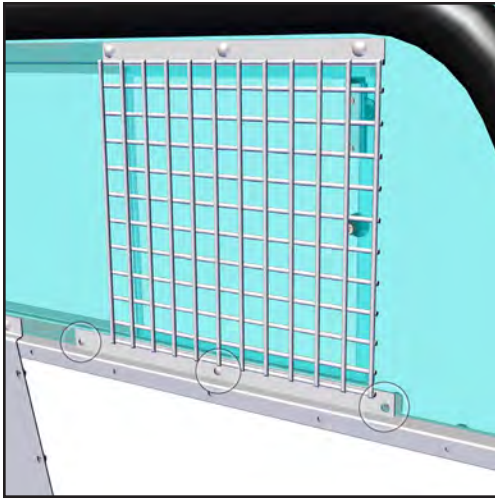

7. Before you install the BDRH you will need to remove the lower Window Channel and Sliding Window by removing the hand tightened carriage bolts and nuts. Remove and set aside for reuse. BDRH-1

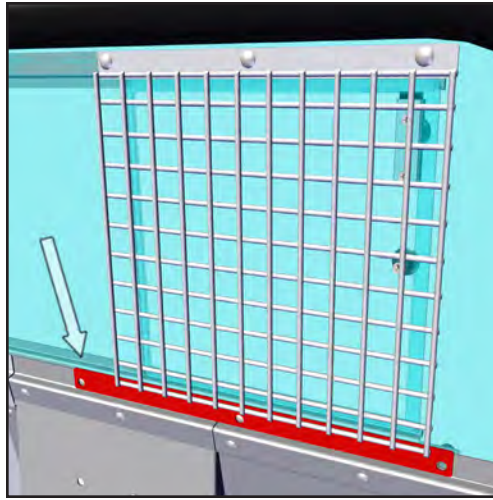

8. When installing the BDRH, be certain the Safety-Wire is installed on the outside of the housing. It will be necessary to pull the bottom of the Safety-Wire out so the BDRH can slip underneath. BDRH-2

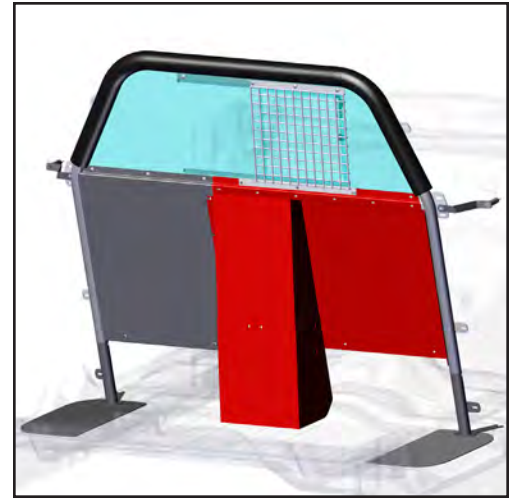

9. Install the assembled BDRH with HSEP to the Partition Frame with previously removed and supplied carriage bolts and flange nuts. Tighten all bolts/nuts. SOLO INSTALL NOTE: Use masking tape over carriage bolts to hold in place while attaching flange nuts from front side of the Partition. BDRH-3

STEP 10 (FOR HS/HV WINDOW ASSEMBLY ONLY)

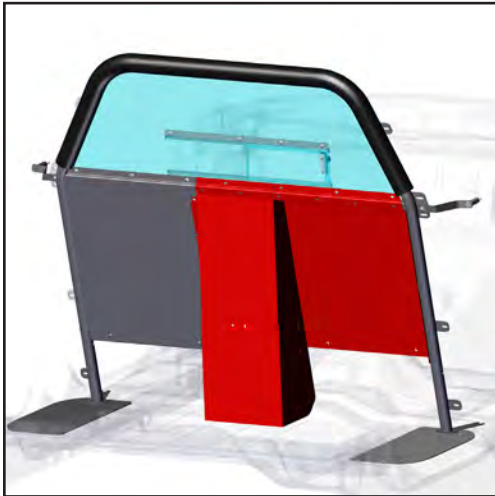

10. Place assembled BDRH with Center HSEP into vehicle. Attach the housing to Partition Frame using carriage bolts and flange nuts. Push Carriage bolts in from prisoner side of Partition. Tighten all bolts / Nuts.

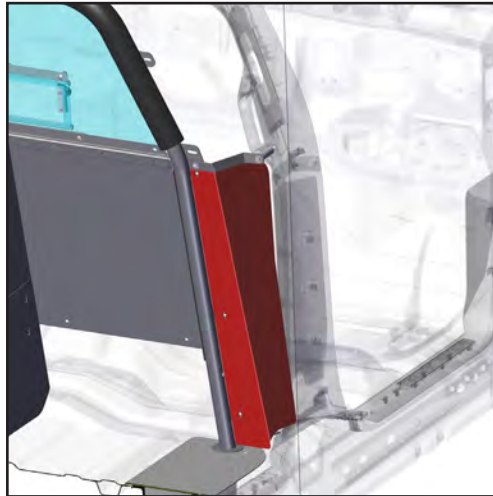

11. Attach the DS/PS Lower Steel Wings from the prisoner side of the Partition using (3) carriage bolts and flange nuts.

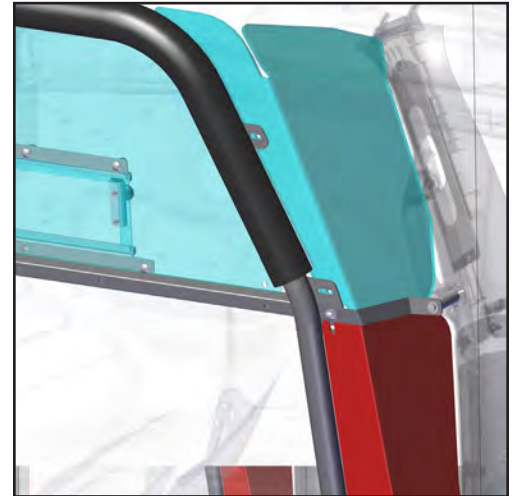

12. Install the Upper PolyWing from the officer side and secure with provided carriage bolts and flange nuts. Check and secure all hardware connections and finish install by placing nut covers on all flange nuts.

If you have questions or need further assistance please call Technical Support: 1.877.455.6886



209 W. EASY ST., ROGERS, AR 72756 • JTOPUBLICSAFETY.COM • 9/25

Jotto Desk™ is a patented product and Registered Trademark of Assembled Products™ Corporation.
Specifications subject to change without notice.

050-0244-00

